



The New Simple Inverter

FVR-Micro Series



FUJI INVERTERS

GREAT PERFORMANCE IN A COMPACT PACKAGE
WELCOME TO THE NEW GENERATION
OF MICRO INVERTERS

Fuji Electric Co., Ltd.

Gate City Ohsaki, East Tower, 11-2,
Osaki 1-chome, Shinagawa-ku,
Tokyo 141-0032, Japan
Phone: +81-3-6717-0617 Fax: +81-3-6717-0585
URL: <http://www.fujielectric.com/>

Printed on recycled paper

Information in this catalog is subject to change without notice.

MEH660

FVR-Micro CONCEPT

Simple! Small!! Smart!!!

Simple,
clear-cut design

Once installed,
enjoy easier
operation



Compact &
Space-saving

The New Compact Inverter

FVR-Micro Series

An economic inverter that demonstrates
great effectiveness with a small initial cost.

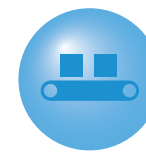

Ideal performance with traversing conveyors

High starting torque of 150% or more

Achieving powerful operation even at low speeds. (when slip compensation control is ON, and when running at 5Hz or more.)

[Torque characteristics example]

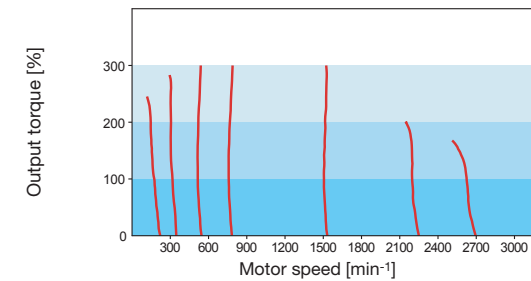

[Output torque characteristics data]

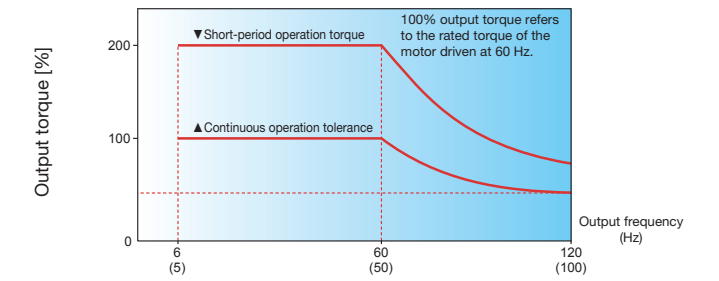

*The graphs show an example of torque characteristics when FVR-Micro is combined at a 1:1 ratio with Fuji's standard 3-phase motor (8-type series: 4-poles).

Continuous operation using the restart function for instantaneous power failure

During an instantaneous power failure, it is possible to automatically restart operation after restoring power. You can select between a mode that restarts operation at the frequency when the power failure occurred or a mode that restarts operation at the starting frequency from operation startup.

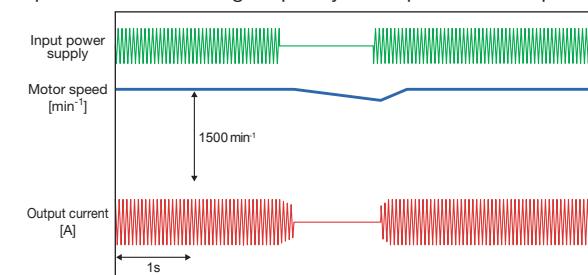

Stable operation even for a step load

The slip compensation function permits stable operation even when the motor load fluctuates (step load).

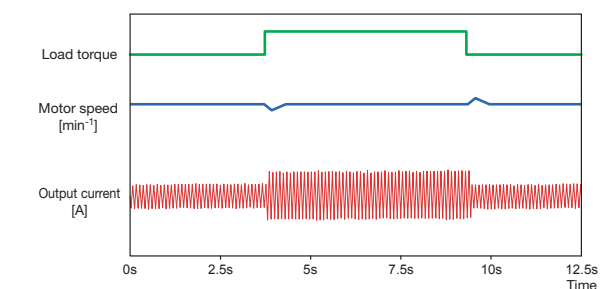

Stable operation even at low speeds

The rotational unevenness even at low speeds (5Hz) is the same level as the FRENIC-Mini which is the higher rank compact model of FVR-Micro.

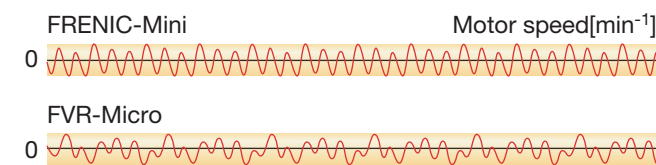

[Motor rotational unevenness characteristics example]



Safety precautions

1. The product descriptions in this catalogue are for the purpose of model selection. Before using the product, be sure to thoroughly read the "Instruction Manual" to ensure proper use.
2. This product is not designed or manufactured for use in systems or equipment on which lives depend. Consult your Fuji Electric representative before considering the products from this documentation for application in systems and equipment related to nuclear power control, aerospace applications, medical applications or transportation. Ensure installation of appropriate safety devices and/or equipment are installed if these products are to be used with any systems or equipment on which lives depend or with systems or equipment which could cause serious loss or damage in the event of product malfunction or failure.

Specifications

Protective functions

External dimensions

How to operate

Terminal functions

Terminal configuration diagram

Connection diagram

Function options

Precautions for use

Energy saving using inverters

Energy savings effect by inverters

- You can save a significant amount of electric power by controlling the inverters when operating fans and pumps, as compared to damper (valve) control.
- Especially when the air flow (flow rate) is low, the energy saving rate increases significantly.

Installing the cooling fan ON/OFF control function

Noise reduction and energy savings are possible by turning off the inverter cooling fan when the fan or pump is not operating.

• When used with a fan

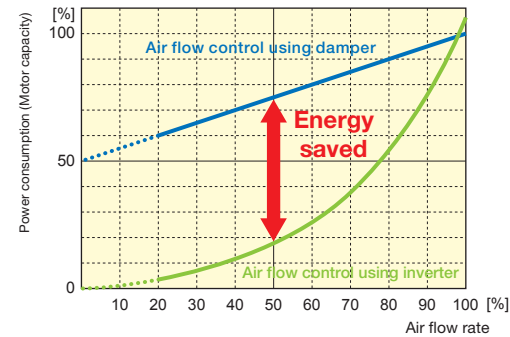

BEST MATCH Ideal functions to serve various needs with small-capacity inverters

Compatible with a wide range of frequency settings

The optimum frequency setting method can be selected to match your machine or equipment. Settings are performed by keypad operation (▲▼ keys, potentiometer), analog input (4 to 20mA, 0 to +10V, 0 to 5V, 1 to 5V), or multistep speed settings (8 steps) etc.

A transistor output and a relay output are respectively provided.

This enables information signals such as running, frequency arrival, ready to operation signals to be output.

The output frequency can be set to a maximum of 400Hz.

The inverter can be used for equipment that requires a high motor speed such as centrifugal separator. (In this case, check the operation in combination with the motor.)

Non-linear V/f pattern setting is possible.

One point for the non-linear V/f pattern, which can be set as desired, has been added, and so the V/f pattern can be adjusted to match the application.

Compact

Built-in RS-485 communications port (RJ-45) as standard

RS-485 communications are available as standard specification.

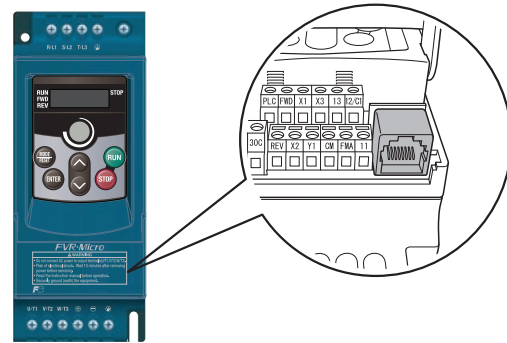

Simple operation and wiring

Frequency setting potentiometer is standard equipment.

Simple manual adjustment of the frequency.

One-touch operation for removal of the control circuit terminal block cover.

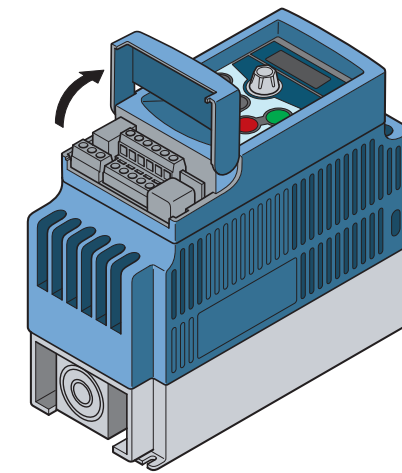

All types of data can be displayed on the keypad.

The setting frequency, output frequency, load speed, output current, output voltage, alarm history and input power, etc., can be displayed.



Maintenance

The alarm history for the 6 latest alarms is recorded.

Alarm history from back as far as the 6 latest alarms can be checked.

Interface for peripheral devices and comprehensive protective functions

All models are equipped with an inrush current suppression circuit.

An inrush current suppression circuit is provided as standard in all models, so the cost of peripheral devices such as input magnetic contactors can be reduced.

Sink/Source can be switched.

The input/output mode (Sink/Source) of the digital input terminals can be switched by means of an internal switch.

Model variation

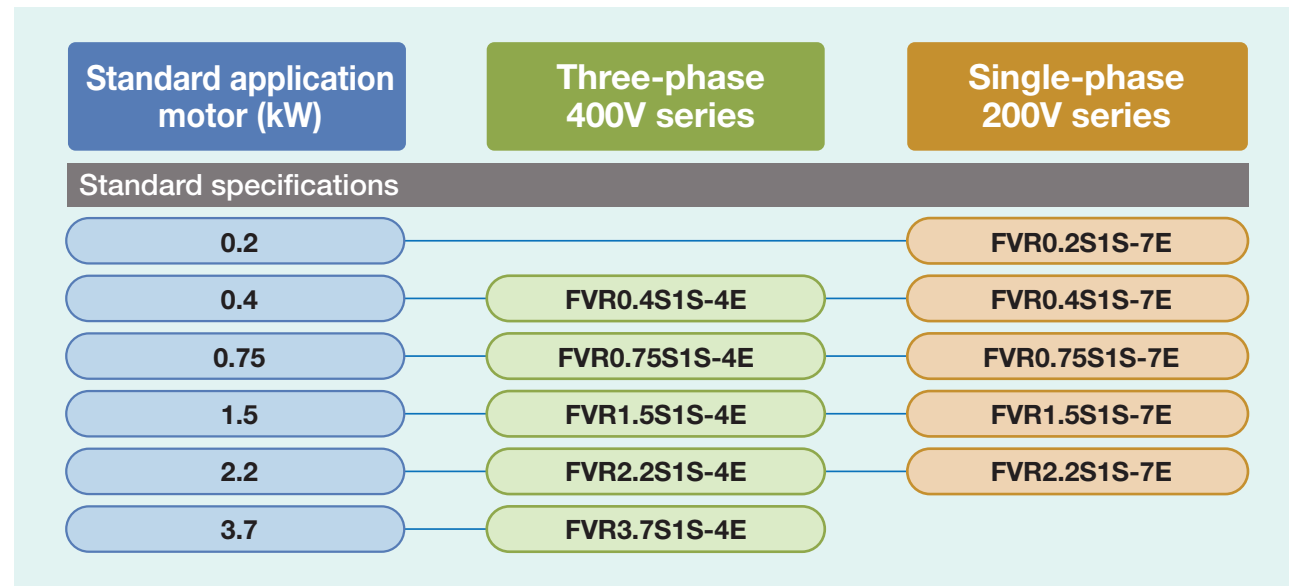

Inverter type description

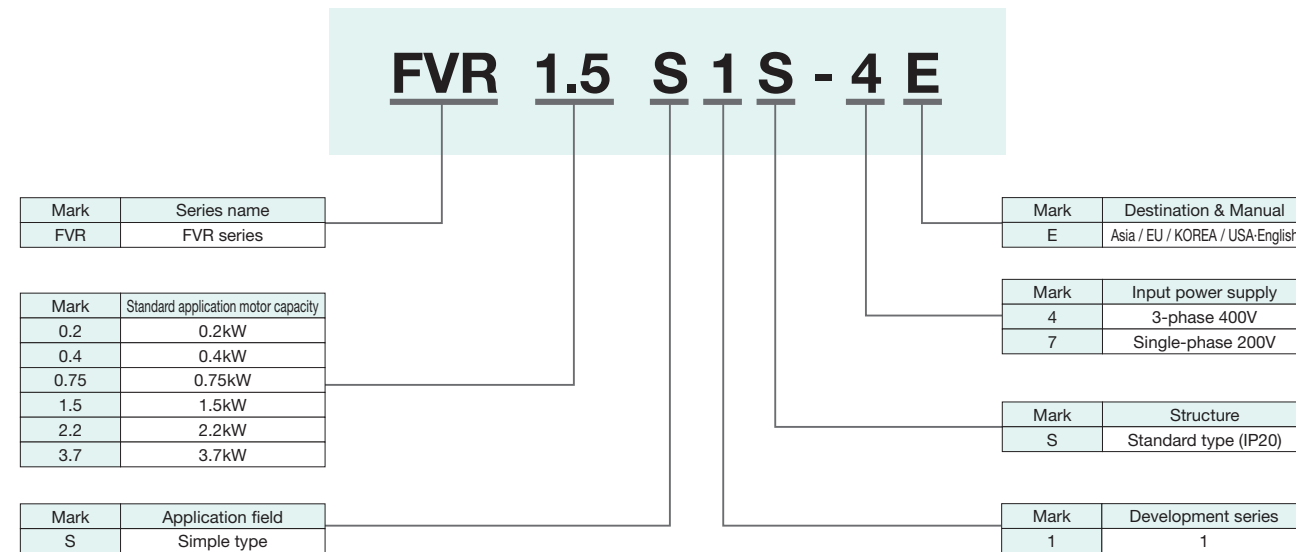

Standard specifications

3 phase 400V series

Items	Specifications					
Power supply series	3 phase 400V					
Type (FRN□□□S1S-□□)	FVR0.4 S1S-4E	FVR0.75 S1S-4E	FVR1.5 S1S-4E	FVR2.2 S1S-4E	FVR3.7 S1S-4E	
Nominal applied motor [kW]	0.4	0.75	1.5	2.2	3.7	
Output ratings	Rated capacity ¹⁾ [kVA]	1.2	2.3	3.2	4.2	6.3
	Rated Voltage ²⁾ [V]	Depends on input power supply				
	Rated current [A]	1.5	2.5	4.2	5.5	8.2
Overload capacity		150% of rated current for 1min				
Input ratings	Q'ty of phase, Voltage and Frequency	3 phase 380 to 460V, 50/60Hz				
	Voltage/Allowable Frequency Fluctuation	Voltage: +10 to -10% ³⁾ Frequency: +5 to -5%				
	Rated current [A] ⁴⁾	1.9	3.5	6.0	7.2	9.0
Required power supply capacity [kVA]		1.3	2.3	4.0	4.8	6.0
Braking	DC Braking	Braking starting frequency: 0.1 to 60.0Hz, Braking level: 40 to 100% rated current Braking time at Starting: 0.0 to 60.0s, Braking time at stopping: 0.0 to 60.0s				
	Enclosure (IEC 60529)	IP20 Close type				
Mass [kg]	1.3	1.3	1.3	1.6	1.7	





¹⁾ Rated capacity shows in a case of Rated 440V
²⁾ It is impossible to output over the power supply voltage
³⁾ Interphase imbalance rate(%) = (Maximum voltage [V] - Minimum voltage [V]) / 3 phase average voltage [V] x 67 (refer to IEC 61800-3)
As for operation of interphase imbalance has become larger, please contact to us.
⁴⁾ The data was calculated under the condition that Fuji has decided.

Single phase 200V series

Items	Specifications					
Power supply series	Single phase 200V					
Type (FRN□□□S1S-□□)	FVR0.2 S1S-7E	FVR0.4 S1S-7E	FVR0.75 S1S-7E	FVR1.5 S1S-7E	FVR2.2 S1S-7E	
Nominal applied motor [kW]	0.2	0.4	0.75	1.5	2.2	
Output ratings	Rated capacity ¹⁾ [kVA]	0.6	1.0	1.9	2.5	4.2
	Rated Voltage ²⁾ [V]	Depends on input power supply				
	Rated current [A]	1.6	2.5	4.2	7.5	11
Overload capacity		150% of rated current for 1min				
Input ratings	Q'ty of phase, Voltage and Frequency	Single phase 200 to 240V, 50/60Hz				
	Voltage/Allowable Frequency Fluctuation	Voltage: +10 to -10% Frequency: +5 to -5%				
	Rated current [A] ⁴⁾	4.9	6.5	10	17.5	27
Required power supply capacity [kVA]		1.1	1.5	2.2	3.9	6.0
Braking	DC Braking	Braking starting frequency: 0.1 to 60.0Hz, Braking level: 40 to 100% rated current Braking time at Starting: 0.0 to 60.0s, Braking time at stopping: 0.0 to 60.0s				
	Enclosure (IEC 60529)	IP20 Close type				
Mass [kg]	1.3	1.3	1.3	1.6	1.9	

¹⁾ Rated capacity shows in the case of Rated 220V
²⁾ It is impossible to output over the power supply voltage
⁴⁾ The data was calculated under the condition that Fuji has decided

Common specifications

	Items	Specifications	Remark
Output frequency	Adjustment		
	Maximum frequency	variable setting 5.0 to 400Hz	
	Base frequency	variable setting 10.0 to 400Hz	
	Starting frequency	variable setting 0.1 to 60.0Hz	
	Carrier frequency	2.0 to 12kHz	
	Setting resolutions	Keypad setting: 0.01Hz (under 99.99Hz), 0.1Hz (100.0 to 400.0Hz)	
Voltage/Frequency characteristics	200V series	<ul style="list-style-type: none"> Able to setting 2.0 to 255V by both Base frequency and Maximum frequency Able to select AVR Control ON/OFF Polygonal line V/f Arbitrary (1point): 2.0 to 255V, 0.1 to 400Hz: able to setting	
	400V series	<ul style="list-style-type: none"> Able to setting 2.0 to 255V by both Base frequency and Maximum output frequency Able to select AVR Control ON/OFF Polygonal line V/f Arbitrary (1 point): 2.0 to 510V, 0.1 to 400Hz:able to setting	
Torque boost		• Function code "1-05", "1-06": set torque boost value	
Starting torque		Over 150% (Setting frequency 5Hz & Slip compensation)	
Start/Stop		Key operation: Start and stop by   key (Keypad panel)	
		<ul style="list-style-type: none"> External signal: Forward (reverse) operation, stop command (able to 3 wired operation) (digital input) Coast to stop command, external alarm, alarm reset, etc. Pattern operation: Automatic operation / stop by set pattern 	
Setting frequency		<ul style="list-style-type: none"> Key operation: ,  key Set by built-in potentiometer Set by external potentiometer (5kΩ 1/2W) 	
(analog input:12/C1 switching mode)		<ul style="list-style-type: none"> 0 to +10Vdc (+5Vdc): Able to set (+5V: analogue input gain, for switching (200%)) +1 to +5Vdc (Able to adjust with bias-analogue input gain) Able to set by 4 to 20mAac 	
(Multi frequency) (Switching mode Of frequency)		Multi frequency operation: Able to select 3-bit external signal with set the 8kinds of frequencies. Able to switch 2kinds of set frequencies by external signal (digital input)	
Control	Acceleration & deceleration time	Variable setting in the range of 0.1 to 600s (as for acceleration and deceleration, Both 2 types of time is able to set)	
	DC braking	Braking starting frequency: 0.1 to 60.0Hz, Braking time: 0.0 to 60.0s (able to set each other, Starting and Stopping). Braking level: 0.0 to 100% variable setting	
	Frequency limiter	Set the Upper / Lower limiters by the ratio against to maximum frequency range: 1 to 110% (Upper limiter), 0 to 100% (Lower limiter)	
	Bias	Able to set the bias value of analog inputted frequency in the range of maximum frequency (0.0 to 100%)	
	Gain	Able to set the gain of analog inputted frequency in the range of maximum frequency (0.0 to 100%)	
	Jump frequency	Jump frequency 3 points and Jump range (0.0 to 400Hz) are able to set	
	Jogging operation	Operate by RUN key or digital input (FWD, REV) (Exclusive frequency, Exclusive acceleration & deceleration time)	
	Restart after instantaneous power failure	Restart the inverter without stop the motor in the case of power recovery	
	Slip compensation control	Compensate the deduction of speed for load and able to stable operation	
	Automatic deceleration	If the DC bus voltage in deceleration become overvoltage limited level, it will stop the deceleration and avoid the OV trip with constant speed operation.	
	Automatic deceleration level setting	Set the over voltage stall prevention level regenerative by function code	
	Cooling fan ON-OFF control	Able to select the mode of cooling fan stop in the case of operation is stopped.	
	Password	Able to set the password by function code. Use each function code for input password and set password.	
	Select deceleration mode	<ul style="list-style-type: none"> Select the deceleration way in the case of operation command "OFF"(normal deceleration or coast-to-stop) Select performance (ignore input or coast-to-stop) in external fault EF signal. 	
	Rotational direction limitation	Able to select the avoidance for Forward or reverse operation	
	Frequency command combination	Addition, subtraction is able to combine with setting frequencies (No.1 and No.2)	
	Reference loss detection	Able to select the operation of reference loss by breaking of frequency reference signal (Terminal C1)	
	UP/DOWN control	Set the frequencies of UP and DOWN command in Digital input terminal.	

Common specifications

	Items	Specifications	Remark	
Indication	Operating, Under Stop	Output frequency (before Slip compensation) [Hz] · Output frequency (after Slip compensation) [Hz] · Output current [A] · Output voltage [V] · DC bus voltage [V] · Input power [kW], etc.		
	Under Trip	[Trip cause] ·OC (overcurrent) ·OV (over voltage) ·OH (overheating of heat sink) ·LU (under voltage) ·OL (overload of inverter "overheating of IGBT") ·OL1 (overload of motor 1) ·OL2 (overload of motor 2), etc.	Refer to the following section	
Protection	Operating, Under Trip	Trip history (last 6 times, indicate and storage)		
	Overcurrent protection	Stop inverter for overcurrent by overload of output side.		
	Short-circuit protection	Stop inverter for overcurrent by short circuit of output side.		
	Overvoltage protection	Stop inverter in case of detect the over DC bus voltage (200V: 400Vdc, 400V: 800Vdc)		
	Undervoltage protection	Indicate the let down DC bus voltage (200V, 200Vdc, 400V: 400Vdc) and stop the inverter.		
	Overload protection	Protect inverter against overheating by overload of IGBT)		
	Motor protection	Electronic thermal	Function of Electronic thermal makes stop the inverter and protect motor (Thermal time constant: able to adjust 0.5 to 10.0 minute)	
		Auto-reset	When it stops for trip, it is able to reset and restart automatically. (Able to set the auto-reset times and the waiting time until the auto-reset)	
	Environment	Installation location	<ul style="list-style-type: none"> Indoor, without corrosive gas, flammable gas and dust (pollution degree 2) Without direct sunlight 	
		Ambient temperature	-10 to +50°C	
Ambient humidity		up to 90%RH (no dew condensation)		
Altitude		Under 1000m		
Vibration		9.80665m/s ² (1g): within up to 20Hz, 5.88m/s ² (0.6g): 20 to 50Hz		
	Storage temperature	-20 to +60°C		

Alarm indication and alarm release & troubleshooting method

Display code	Description	Alarm release & troubleshooting method
OC	An instantaneous value for the inverter output current exceeds the overcurrent level.	<ol style="list-style-type: none"> 1. Compare the motor current value with the inverter rated current, and check whether the inverter capacity is appropriate. 2. Check whether there is a short circuit on the inverter output terminal (U, V, W). 3. Check whether there is a short circuit on the motor connection or grounding. 4. Check whether there is a loose wire connection between the inverter and motor. 5. Increase the acceleration time (1-09, 1-11). 6. Check whether there is an overload on the motor.
OU	The DC bus voltage exceeded the over voltage detection level.	<ol style="list-style-type: none"> 1. Check whether the input voltage exceeded the inverter specification range, or whether there was a surge that entered the input power supply. 2. Recalculate the deceleration torque from the load inertia moment and deceleration time, and increase the deceleration time.
oH	The internal temperature on the inverter rose abnormally.	<ol style="list-style-type: none"> 1. Measure the ambient temperature. 2. Check whether there is something obstructing or stuck to the heat sink and whether the heat sink is operating properly. 3. Check whether the inverter installation space is secure and free of obstruction.
LU	The DC bus voltage dropped below the under voltage level.	<ol style="list-style-type: none"> 1. Check whether the input voltage is correct. 2. Check whether there are any sudden load increases.
oL	The output current exceeded the inverter's overload capacity (150%/60 sec.).	<ol style="list-style-type: none"> 1. Check whether there is an overload during operation. 2. Increase the inverter capacity.
oL1	The electronic thermal function for motor overload detection was activated.	<ol style="list-style-type: none"> 1. Check whether there is an overload on the motor. 2. Check the [7-00] motor's total load capacity current setting. 3. Check the electronic thermal function setting. 4. Increase the motor capacity.
oL2	Motor overload	<ol style="list-style-type: none"> 1. Check the motor's output current. 2. Check the over torque detection standard setting value (6-03).
EF	When the CM short circuits with the external multifunction input terminal, used for the external alarm function (EF), the inverter stops output.	Release the cause of the alarm, and push the "RESET" key.
cF1	Internal memory IC data writing error	<ol style="list-style-type: none"> 1. Turn the power supply OFF and turn it ON again. 2. Make a repair request to the manufacturer.
cF2	Internal memory IC data reading error	<ol style="list-style-type: none"> 1. Push the RESET key and restore the default setting. 2. If this method is ineffective, send the product back to the manufacturer for repair.
cF3.1	Internal temperature increase during startup.	<ol style="list-style-type: none"> 1. Measure the ambient temperature. 2. If the ambient temperature is normal, send the product back to the manufacturer for repair.
cF3.2	The DC bus voltage exceeded the over voltage level during startup.	<ol style="list-style-type: none"> 1. Check whether the input voltage exceeded the inverter specification range. 2. If the input voltage is normal, send the product back to the manufacturer for repair.
cF3.3	The DC bus circuit voltage dropped below the under voltage level during startup.	<ol style="list-style-type: none"> 1. Check whether the input voltage is correct. 2. If the input voltage is normal, send the product back to the manufacturer for repair.
HPF.1	Over voltage protection circuit error	Make a repair request to the manufacturer.
HPF.3	Over current protection circuit error	Make a repair request to the manufacturer.
bb	When inputting this function from the external multifunction terminal, the inverter stops output.	If the input signal is cleared, "bb" will disappear.
CE--	Communications error	<ol style="list-style-type: none"> 1. Check whether the communication circuit is connected correctly. 2. Check whether the communications format is correct.
Errb	There is a wobble frequency setting error, the central frequency of wobble frequency is below the amplitude setting, or the wobble frequency maximum value exceeds the upper and lower limit for the output frequency range.	Set the correct wobble frequency parameters.

External dimensions

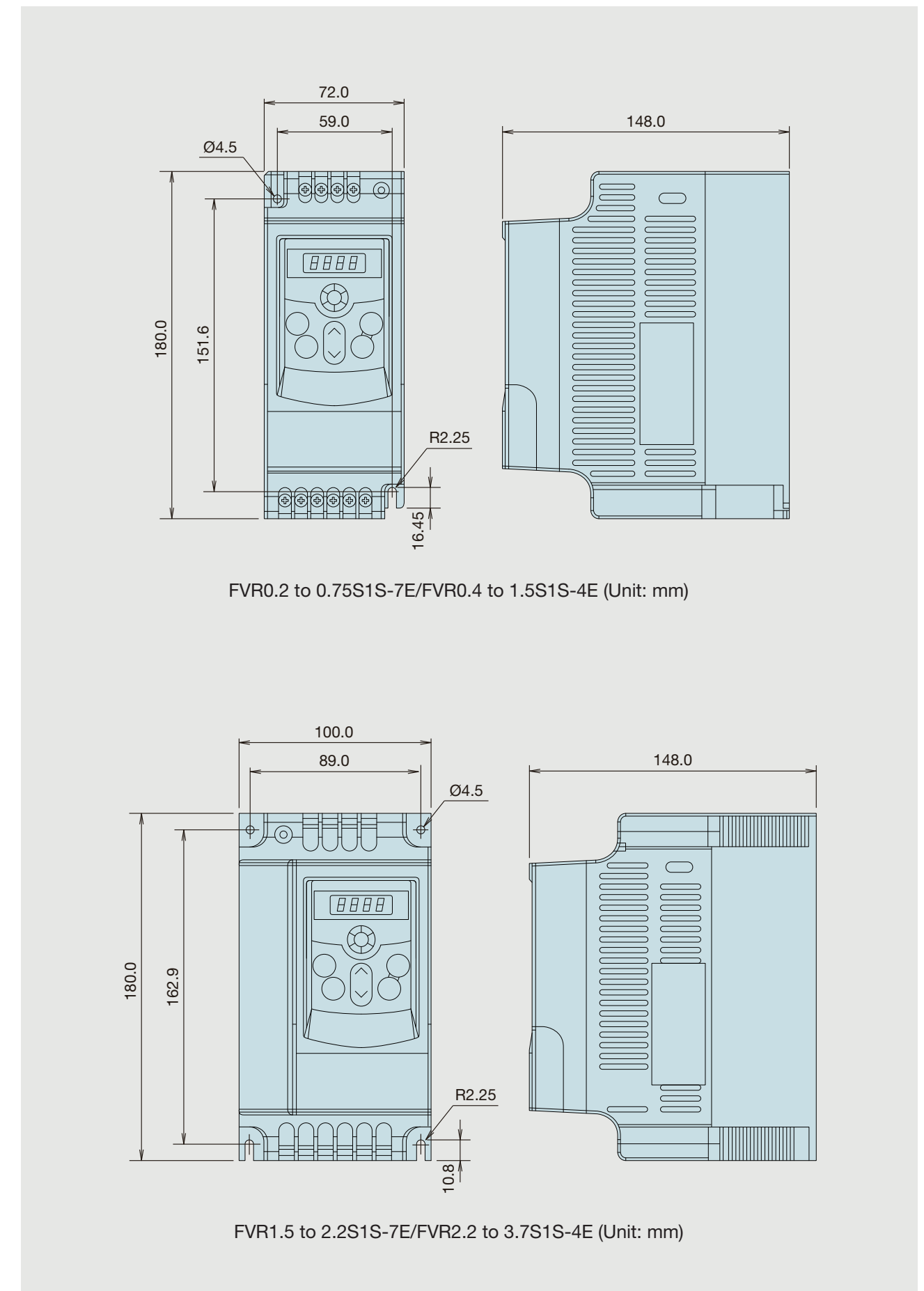

Protective functions
External dimensions

How to operate

Each section name and function for the keypad

LED monitor

During operation or a stop:
Displays speed monitor (Output frequency (Before slip compensation), output frequency (After slip compensation), setting frequency, motor speed, load rotational speed, etc.), output current, output voltage, input power, etc.

Alarm mode:
Displays the alarm description with a code.

Mode key / Reset key

Switches between modes.

Normal mode:
You can switch on the LED monitor.

Alarm mode:
Releases the trip stoppage.

Function key input

Used to display and check the function code and data.

Up / Down keys

During operation: Used to increase and decrease the frequency and speed.

When setting: Changes the function code display and the data setting value.

Potentiometer

Used for frequency setting.

Operation key

This key starts the running operation.

While stopped:
When the function code `2-03` is set to something besides "`0`" (keypad operation), it will not operate.







Stop key

This key stops the running operation.

While operating:
Operation is not enabled when the function code `2-03` is set to "`2`" (Running from an external signal (Keypad stop key disabled)) or "`4`" (Running via RS-485 communications (Keypad stop key disabled)).



Display and key operations The keypad modes are divided into the following 3 modes.

Display section & operation section	Operation modes	Programming mode		Running mode		Alarm mode
		Stopped	Operating	Stopped	Operating	
Display section 	Function	Display function code and data		Display output frequency, setting frequency, load rotation speed, input power, output current, output voltage, etc.		Display alarm description
	Display	Light on		Light on		Light on
Operation section	 Function	Change to stop mode	Change to operation mode	Switch to display contents on LED monitor		Release trip and change to stop mode or operation mode
	 Function	Select and set function code, and record & update data		Change mode to program mode (while stopped)	Change mode to program mode (while operating)	Disabled
	 Function	Increase/decrease function code and data		Increase/decrease setting, such as frequency setting		Disabled
	 Function	Change to program mode (while operating)	Disabled	Change to operation mode (while operating)	Disabled	Disabled
	 Function	Disabled	Change to program mode (while stopped)	Disabled	Change to operation mode (while stopped)	Disabled

Terminal Functions

Sort	Symbol	Terminal name	Specifications	Remark
Main Circuit	L1/R, L2/S, L3/T	Main power supply	Connect to the 3-Phase power supply.	
	L1/L, L2/N		Connect to the single phase power supply.	
	U, V, W	Inverter output	Connect to 3-phase motor.	
	(+), (-)	Brake unit connection use	Connect with braking unit (option).	
	⊕G	Inverter earth connection use	Inverter earth connection terminal.	
Frequency Setting	13	Potentiometer power supply	Use frequency setting (potentiometer: 5kΩ) as power supply. (10Vdc 3mAdc max.)	
	12/C1 Change-over by switch	Frequency setting voltage input	0 to +10Vdc/0 to 100% (0 to +5Vdc/0 to 100%)	Input impedance: 47kΩ
		Frequency setting current Input	4 to 20mAdc/0 to 100%	Input impedance: 250Ω
11	Analog common	Common terminal for analog input / output signals (12, 13, C1, FMA).	Isolate to CM terminal .	
Digital input	FWD	FWD operation command	<ul style="list-style-type: none"> The functions below can be set on terminal X1-X3, FWD and REV. <Common Function> Sink/Source can be switched by the jumper switch built-in the inverter 	FWD, REV terminal can also be used for other functions. Switch SINK/SOURCE by switch.
	REV	REV operation command		
	X1	Digital input 1		
	X2	Digital input 2		
	X3	Digital input 3		
	(NONE)	No Function	No affect to behavior both ON/OFF	
	(FWD)	FWD operation command	When (FWD) is ON, forward operation, when OFF, it will stop after deceleration	Setting is only available to FWD, REV terminals
	(REV)	REV operation command	When (REV) is ON, reverse operation, when Off, it will stop after deceleration	
	(CRUN)	Run/stop command	When (CRUN) is ON, it runs, when OFF it will stop after deceleration.	
	(FWD/REV)	FWD/REV command	When (CRUN) is ON, and (FWD/REV) is ON, forward operation, when (FWD/REV) is OFF, reverse operation	
	(HLD)	3-wire operation/ stop command	<ul style="list-style-type: none"> Used as self hold signal in 3-wire operation case. When (HLD) is ON, (FWD) or (REV) signal will be self held and it will be released when the signal is OFF 	
	(EF1)	EF, Normal Open input	<ul style="list-style-type: none"> The inverter output is shut off immediately and the motor coasts-to-stop when (EF1) is ON. 	
	(EF2)	EF, Normal close input	<ul style="list-style-type: none"> The inverter output is shut off immediately and the motor coasts-to-stop when (EF2) is OFF. 	
	(RST)	Alarm reset	The alarm hold will be released when (RST) is ON.	
	(SS1) (SS2) (SS4)	Multi frequency selection	8 step speed running is possible by the ON/OFF signal from (SS1) to (SS4).	
	(Hz2/Hz1)	Frequency setting2/frequency setting1	When (Hz2/Hz1) is ON, frequency setting 2 will be selected.	
	(HLR-HLD)	Acceleration prohibition command	When (HLR-HLD) is ON the acceleration and deceleration will be prohibited.	
	(RT1)	Acceleration time selection	Selection of acceleration/deceleration time 2/1 is possible by the ON/OFF of (RT1).	
	(BB1)	External alarm, normal open input	Output of inverter shall stop immediately by (B.B) ON.	
	(BB2)	External alarm, normal close input	Output of inverter shall stop immediately by (B.B) OFF.	
(UP)	UP Command	Frequency up command will be done by (UP) ON.		
(DOWN)	DOWN Command	Frequency down command will be done by (DOWN) ON		
(AUTO)	Pattern operation command	Pattern operation can be started by (AUTO) ON.		
(PAUSE)	Pattern operation interruption command	Pattern operation can be paused by (PAUSE) ON.		
(JOG-f)	Jogging frequency command	Select jogging frequency by (JOG-f) ON.		
(CNT-RST)	Counter reset	Reset current count by (CNT-RST) ON.		
(SEL-C1)	C1 terminal selection	Select input from terminal C1 by (SEL-C1) ON.		
(JOG-FWD)	Jogging FWD command	Jogging FWD by (JOG-FWD) ON.		
(JOG-REV)	Jogging REV	Jogging REV by (JOG-REV) ON.		
(WFI)	Wobble frequency input	Start wobble frequency operation by (WFI) ON.		
(WFI-RST)	Wobble frequency input reset	Start wobble frequency operation by (WFI-RST) ON.		
(EN1)	Emergency stop 1 normal open input	Emergency stop by (EN1) ON.		
(EN2)	Emergency stop 2 normal close input	Emergency stop by (EN2) OFF.		
(CNT)	Counter trigger signal	Counter signal is input to (CNT)		
PLC	PLC signal power supply	Connect with the PLC output signal power supply. Also available as 24V power supply.	+24V Max. 20mA	
CM	Digital input common	Common terminal of digital input signal	Isolate from terminal 11	

Terminal Functions

Sort	Symbol	Terminal name	Specifications	Remark
Analog output	FMA	Analog monitor	One item selected from items below can be output by DC voltage. <ul style="list-style-type: none"> output frequency 1 (before slip compensation) output frequency 2 (after slip compensation) output current output voltage DC bus voltage Input power *analog voltmeter (0 to 10Vdc, Max 3mA input impedance: 3.3kΩ) can be used. Gain adjustment range:1 to 200%	
	Y1	Transistor output	<ul style="list-style-type: none"> Output the selected signal from below. (48Vdc, Max. 50mAdc) 	
Transistor output/Relay output	30A, 30B, 30C	Alarm output (for any alarm) (Relay output)	<ul style="list-style-type: none"> When inverter stops during alarm, the voltage-less point signal (1c) will be output. The following signal is selectable as multi-purpose relay output (contact rating: 240Vac, 1.5Aac (Normal open)/0.5Aac(Normal close)) The alarm output is switchable by excitation or non-excitation. 	
	(NON)	No function		
	(RUN)	Inverter running	ON signal will be output when inverter runs over starting frequency.	
	(FAR)	Frequency arrival	ON signal will be output when output frequency reaches the setting frequency. Detecting range is(ON: 1.0Hz, OFF: 3.0Hz)fixed.	
	(ZERO)	Zero speed	ON signal will be output during stop.	
	(OT)	Over torque detection	ON signal will be output by over torque detection.	
	(BB)	During external alarm	ON signal will be output during outside base block by base block signal.	
	(LU)	Low voltage detection	ON signal will be output by under voltage.	
	(REM)	External terminal running mode	ON signal will be output under running mode from external terminal.	
	(ALM)	Alarm output (for any alarm)	Batch alarm signals can be output as transistor output signal.	
	(FDT)	Frequency detection	ON signal will be output when the output frequency is over the setting detection level.	
	(AUTO)	During pattern operation	ON signal output during pattern operation	
	(TO)	Pattern operation one cycle completion	ON signal will be output after 1 cycle pattern operation completes.	
	(TE)	Pattern operation completion	ON signal will be output when pattern operation completes.	
	(TP)	Pattern operation pause	ON signal will be output during pattern operation pause.	
	(CAR)	Terminal count value arrival	ON signal output on terminal value arrival.	
	(CARF)	Terminal designated count value arrival	ON signal output on terminal designated count value arrival	
(RDY)	Inverter ready to run	ON signal will be output when inverter running preparation is finished.		
(FRUN)	Fwd running	ON signal output during FWD operation.		
(RRUN)	Rev running	ON signal output during REV operation.		
(FRRUN)	Fwd/Rev running direction	OFF during FWD operation, ON during REV operation.		
CM	Transistor output common	Emitter terminal for transistor output signal (Y1)	Isolate from terminal 11	
communications	RS-485 Communications connector (RJ-45 connector)	RS-485 communications Input/output	Modbus-RTU protocol is built in the inverter	

Terminal configuration diagram

Main circuit terminals

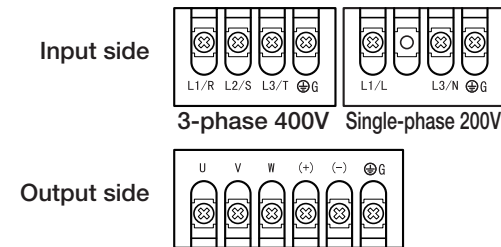

Control circuit terminals

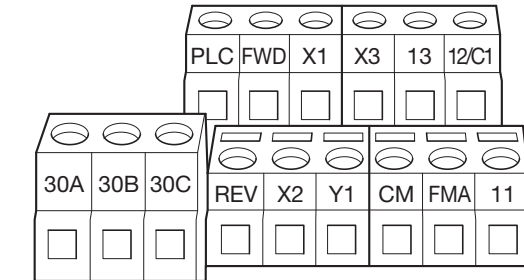

Basic connection diagram

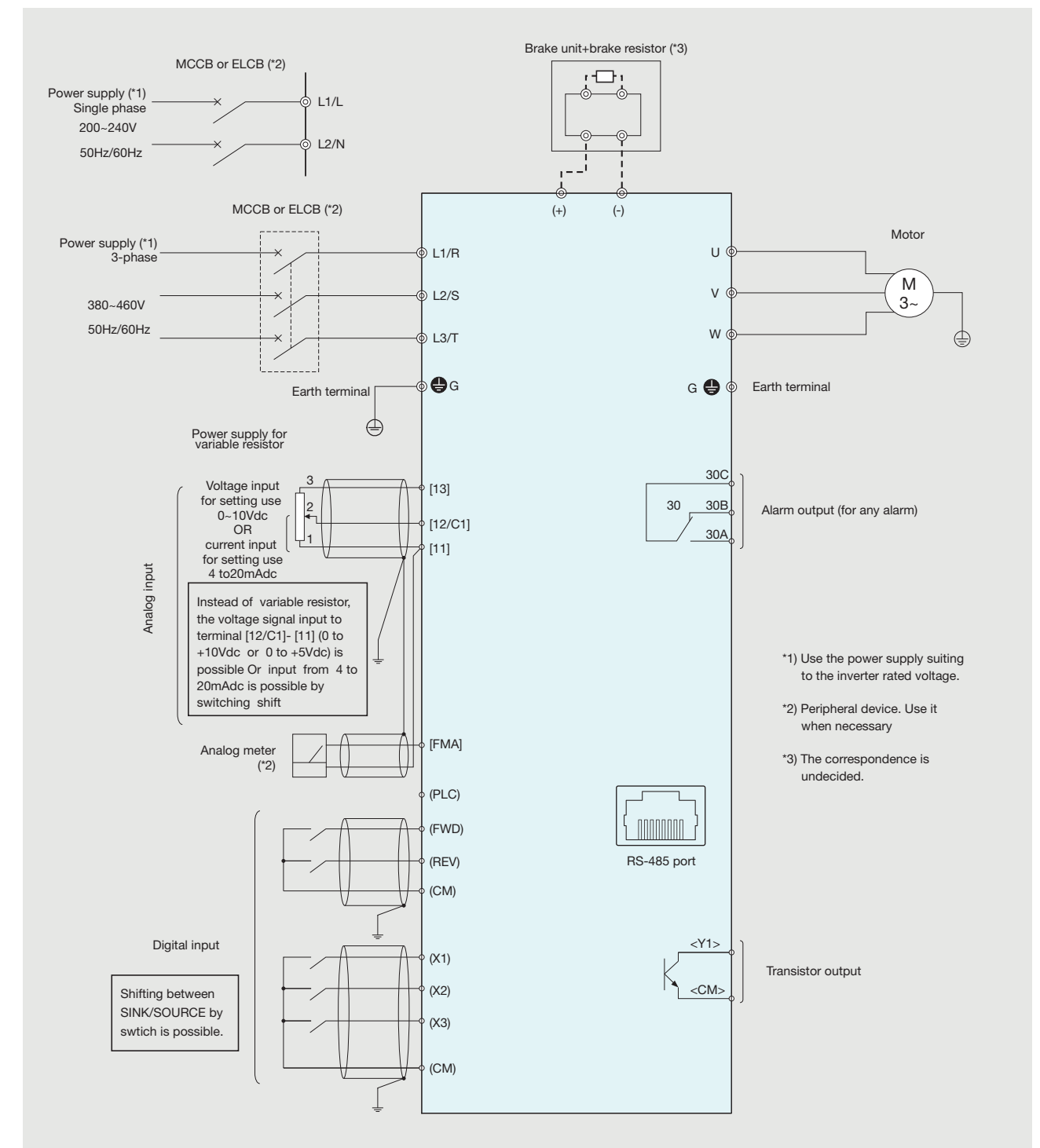

Terminal functions

Terminal configuration diagram

Connection diagram

List of function options

User's Parameters

Code	Name	Data Setting range	Increment	Unit	Default setting
0-00	Inverter type code recognition (Only for reading)	1:200V/0.2kW 2:200V/0.4kW 3:200V/0.75kW 4:200V/1.5kW 5:220V/2.2kW 10:400V/0.4kW 11:400V/0.75kW 12:400V/1.5kW 13:400V/2.2kW 14:400V/3.7kW	-	-	#
0-01	Rated current display of Inverter (Only for reading)	200V/0.2kW:1.6A 200V/0.4kW:2.5A 200V/0.75kW:4.2A 200V/1.5kW:7.5A 200V/2.2kW:11.0A 400V/0.4kW:1.5A 400V/0.75kW:2.5A 400V/1.5kW:4.2A 400V/2.2kW:5.5A 400V/3.7kW:8.2A	-	-	###
0-02	Data initialization	0 to 9,11 to 20:no function 10:Parameter reset to factory setting	-	-	0
0-03	Machine on display selection	0:F (Display set frequency reference) 1:H (Display actual running frequency) 2:U (Display multi-function determination) 3:A (Display motor running current)	-	-	0
0-04	Determining multifunctional display	0:Displaying output physical quantity (U) defined by operators 1:Displaying count value (C) 2:Displaying program operation content (X=tt) 3:Displaying DC-BUS voltage (U) 4:Displaying output voltage (E) 5:Displaying rotating speed (R) 6:Output frequency 2 (after slip compensation) (H) 7:Consumed power (P)	-	-	0
0-05	Proportional constant setting	0.1 to 160	0.1	-	1.0
0-06	Software version	Only for reading	-	-	###
0-07	Input parameter password protection	0 to 999	1	-	0
0-08	Setting parameter password protection	0 to 999	1	-	0

Basic Parameters

Code	Name	Data Setting range	Increment	Unit	Default setting
1-00	Maximum frequency	5.0 to 400Hz	0.1	Hz	50.0
1-01	Base frequency	10.0 to 400Hz	0.1	Hz	50.0
1-02	Rated voltage at base frequency	200V:2.0 to 255V 400V:2.0 to 510V	0.1	V	220 440
1-03	Intermediate frequency setting	0.1 to 400Hz	0.1	Hz	1.0
1-04	Intermediate voltage setting	200V:2.0 to 255V 400V:2.0 to 510V	0.1	V	12.0 24.0
1-05	Starting frequency	0.1 to 60.0Hz	0.1	Hz	1.0
1-06	Output voltage at starting frequency	200V:2.0 to 255V 400V:2.0 to 510V	0.1	V	12.0 24.0
1-07	Frequency limiter (Upper)	1 to 110%	1	%	100
1-08	Frequency limiter (Lower)	0 to 100%	1	%	0
1-09	Acceleration time 1	0.01 to 600s	0.01	s	10.0
1-10	Deceleration time 1	0.01 to 600s	0.01	s	10.0
1-11	Acceleration time 2	0.01 to 600s	0.01	s	10.0
1-12	Deceleration time 2	0.01 to 600s	0.01	s	10.0
1-13	Acceleration time (JOG)	0.01 to 600s	0.01	s	10.0
1-14	Deceleration time (JOG)	0.01 to 600s	0.01	s	10.0
1-15	JOG frequency setting	1.0 to 400Hz	0.01	Hz	6.0
1-19	V/f curve setting	0 to 6	1	-	0

Operation Mode Parameters

Code	Name	Data Setting range	Increment	Unit	Default setting
2-00	Frequency command 1	0:Keys on keypad 1:Input DC 0 to 10V by external terminals 12 2:Input DC 4 to 20mA by external terminals C1 3:Controlled by VR on keypad 4:Operated by RS-485 communications interface 5:Operated by RS-485 communications interface (Frequency memory) 6:Controlled by UP/DOWN 7:Controlled by UP/DOWN (Frequency memory)	-	-	3
2-01	Frequency command 2	0: Keys on keypad 1:Input DC 0 to 10V by external terminals 12 2:Input 4 to 20mA by external terminals C1 3:Controlled by VR on keypad panel 6:Controlled by UP/DOWN 7:Controlled by UP/DOWN (Frequency memory)	-	-	0
2-02	Combination way of frequency sources	0:Frequency command 1 1:Frequency command 1 + Frequency command 2 2:Frequency command 1 - Frequency command 2	-	-	0
2-03	Operation method	0:Operated by keypad 1:Operated by external terminals. STOP on keypad available 2:Operated by external terminals. STOP on keypad unavailable 3:Operated by communications Interface RS-485. STOP on keypad available 4:Operated by communications Interface RS-485. STOP on keypad unavailable	-	-	0
2-04	Deceleration mode	0:Normal deceleration 1:Coast to stop	-	-	0
2-05	External fault (EF) stop mode	1:External fault (EF) coast to stop	-	-	1
2-07	Reference loss detection (Terminal 12) (Stop mode)	0:Deceleration stop 1:Coast to stop 2:Holding operation command after deceleration stop	-	-	2
2-09	Motor sound (Carrier frequency)	2.0 to 12.0kHz	0.1	kHz	6.0
2-10	Rotation direction limitation	0:Fwd/Rev run available 1:Rev run inhibited 2:Fwd run inhibited	-	-	0
2-11	Reference loss detection (Terminal C1) (Stop mode)	0:Non-processing 1:Coast to stop 2:EF display after deceleration stop 3:Continuous operation by reference frequency before disconnection	-	-	0
2-12	Power on start	0:Operation available 1:Operation unavailable	-	-	0

Notes:

- 1) In 2-00 and 2-01, when 2-00 has been set as d1 (12) or d2 (C1), 2-01 can't be set as d1 or d2 again.
- 2) In 2-00 and 2-01, when 2-00 has been set as d6 or d7 (controlled by UP/DOWN), 2-01 can't be set as d6 or d7 again.
- 3) The parameter of 2-07 is valid only when the frequency is given by analog input 12 and input set 0. If the frequency is given by 12, but press the STOP key, the inverter will stop still according to the mode of 2-04.

<Changing, validating and saving data during operation>

□: Not possible □:After changing with the ⏪⏩ keys, validate or save the data with "Enter" key.

List of function options

Output Function Parameters

Code	Name	Data Setting range	Increment	Unit	Default setting
3-00	Frequency detection (Level)	1.0 to 400Hz	0.1	Hz	1.0
3-01	Count value agreement setting	0 to 999	1	-	0
3-02	Appointed count agreement setting	0 to 999	1	-	0
3-03	Fwd run reference delay setting	0.0 to 60.0s	0.1	s	0.0
3-04	Rev run reference delay setting	0.0 to 60.0s	0.1	s	0.0
3-05	Terminal [30A/B/C] function (Relay output) Normally open contactor (30A-30C) Normally closed contactor (30B-30C)	0:No function 1:Inverter running 2:Frequency arrival 3:Zero speed 4:Over-torque detection 5:During external alarm 6:Low voltage detection 7:External terminal running mode 8:Alarm output (for any alarm) 9:Frequency detection 10:During pattern operation 11:Pattern operation one cycle completion 12:Pattern operation completion 13:Pattern operation pause 14:Terminal count value arrival 15:Terminal designated count value arrival 16:Inverter ready to run 17:Fwd running 18:Rev running 19:Fwd/Rev running direction	-	-	8
3-06	Analog output setting	0:Output frequency 1 (before slip compensation) 1:Output frequency 2 (after slip compensation) 2:Analog current meter (0 to 250% of rated current) 3:Analog output voltage 4:Analog DC bus voltage 5:Input power	-	-	0
3-08	Analog output gain selection	1 to 200%	1	%	100
3-09	Terminal [Y1] function	0:No function 1:Inverter running 2:Frequency arrival 3:Zero speed 4:Over-torque detection 5:During external alarm 6:Low voltage detection 7:External terminal running mode 8:Alarm output (for any alarm) 9:Frequency detection 10:During pattern operation 11:Pattern operation one cycle completion 12:Pattern operation completion 13:Pattern operation pause 14:Terminal count value arrival 15:Terminal designated count value arrival 16:Inverter ready to run 17:Fwd running 18:Rev running 19:Fwd/Rev running direction	-	-	1
3-11	Dead time setting of Fwd and Rev changeover	0.0 to 600 s	0.1	s	0.0
3-12	Cooling fan control	0:Fan continuous running 1:Run for 1 minute after pressing stop key 2:Operate/stop along with inverter	-	-	0
3-13	Bias [12] (Bias base point)	0.0 to 10.0V	0.1	V	0.0
3-14	(Bias value)	0.0 to 100% of Maximum frequency	0.1	%	0.0
3-15	Analog input adjustment for [12] (Gain base point)	0.0 to 10.0V	0.1	V	10.0
3-16	(Gain)	0.0 to 100% of Maximum frequency	0.1	%	100
3-17	Bias [C1] (Bias base point)	0.0 to 20.0mA	0.1	mA	4.0
3-18	(Bias value)	0.0 to 100% of Maximum frequency	0.1	%	0.0
3-19	Analog input adjustment for [C1] (Gain base point)	0.0 to 20.0mA	0.1	mA	20.0
3-20	(Gain)	0.0 to 100% of Maximum frequency	0.1	%	100

Input Function Parameters

Code	Name	Data Setting range	Increment	Unit	Default setting
4-00	[VR] Input frequency bias setting	0.0 to 350Hz	0.1	Hz	0.0
4-01	[VR] Input frequency bias adjustment direction	0:Positive direction 1:Negative direction	-	-	0
4-02	[VR] Input frequency gain setting	1 to 200%	1	%	100
4-03	[VR] Negative bias operation setting	0:No negative bias 1:Reversible negative bias 2:Not reversible negative bias	-	-	0
4-04	Terminal [FWD] function (Setting range from d0 to d31)*	0:No function 1:FWD: forward run/stop, REV: reverse run/stop	-	-	1
4-05	Terminal [REV] function (Setting range d0, d5 to d31)	2:FWD: run/stop, REV: fwd/rev run 3:3-wire operation control (1): FWD run, REV fwd/rev run, X1 STOP (Normally closed)	-	-	0
4-06	Terminal [X1] function (Setting range d0, d5 to d31)	4:3-wire operation control (2): FWD run (Triggering), REV run (Triggering), X1 STOP (Normally closed)	-	-	8
4-07	Terminal [X2] function (Setting range d0, d5 to d31)	5:External fault (EF), normally open interface input (N.O) 6:External fault (EF) normally closed interface input (N.C) 7:RESET alarm	-	-	9
4-08	Terminal [X3] function (Setting range d0, d5 to d31)	8>Select multi-frequency (0 to 1 steps) 9>Select multi-frequency (0 to 3 steps) 10>Select multi-frequency (0 to 7 steps) 12>Select frequency command 2/1 13:Accel/Decel inhibition command 14>Select 1 st and 2 nd Accel/Decel time 15:External alarm, normally open (NO) input 16:External alarm, normally closed (NC) input 17:Up command 18:Down command 19:Pattern operation command 20:Pattern operation pause command 21:JOG frequency reference 22:Count reset 24:JOG-FWD 25:JOG-REV 27:Wobble frequency function input 28:Wobble frequency state reset 29:Inhibiting output (N.O) 30:Inhibiting output (N.C) 31:Counter trigger signal input	-	-	7
4-09	Speed tracking after external alarm reset	0:Tracking downwards from speed before external alarm 1:Tracking upwards from min speed	-	-	0

Notes: When 4-04 is set as d1 to d2, function set by REV is invalid. When 4-04 is set as d3 to d4, function set by REV and X1 is invalid.

Multi-Step Speed and Pattern Operation Parameters

Code	Name	Data Setting range	Increment	Unit	Default setting	
5-00	Multi frequency 1	0.0 to 400Hz	0.1	Hz	0.0	
5-01		2	0.0 to 400Hz	0.1	Hz	0.0
5-02		3	0.0 to 400Hz	0.1	Hz	0.0
5-03		4	0.0 to 400Hz	0.1	Hz	0.0
5-04		5	0.0 to 400Hz	0.1	Hz	0.0
5-05		6	0.0 to 400Hz	0.1	Hz	0.0
5-06		7	0.0 to 400Hz	0.1	Hz	0.0
5-15	Pattern operation (Mode)	0:Pattern operation inactive 1:Active (Stop after operating for 1 cycle) 2:Active (Pattern operation performs in cycles until STOP command input) 3:Active (Stop after operating for 1 cycle) (with STOP intervals). 4:Active (Pattern operation performs in cycles until STOP command input) (with STOP intervals).	-	-	0	
5-16	(Rotating direction)	0 to 255 (0: Forward Run 1: Reverse Run)	1	-	0	
5-18	(Step 0 time)	0 to 65500s	1	s	0	
5-19	(Step 1 time)	0 to 65500s	1	s	0	
5-20	(Step 2 time)	0 to 65500s	1	s	0	
5-21	(Step 3 time)	0 to 65500s	1	s	0	
5-22	(Step 4 time)	0 to 65500s	1	s	0	
5-23	(Step 5 time)	0 to 65500s	1	s	0	
5-24	(Step 6 time)	0 to 65500s	1	s	0	
5-25	(Step 7 time)	0 to 65500s	1	s	0	

<Changing, validating and saving data during operation>

□: Not possible □:After changing with the ⏪⏩ keys, validate or save the data with "⏹" key.

List of function options

Protection Parameters

Code	Name	Data Setting range	Increment	Unit	Default setting
5-00	Over voltage stall prevention function	0:Inactive 200V series:340-400V 400V series:680-800V	-	-	370 740
5-02	Over-torque detection (Mode selection)	0:No detection 1:Over torque detection (OL2) during constant speed running, continue to run after detection. 2:Over torque detection (OL2) during constant speed running, stop running after detection. 3:Over torque detection (OL2) during acceleration, continue to run after detection. 4:Over torque detection (OL2) during acceleration, stop running after detection.	-	-	0
5-03	(Detection level)	30 to 200%	1	%	150
5-04	(Detection time)	0.1 to 10.0s	0.1	s	0.1
5-05	Electronic thermal overload protection for Motor (Select motor characteristics)	0:Inactive 1:Active (For a general-purpose motor with shaft-driven cooling fan) 2:Active (For a motor with separately powered cooling fan)	-	-	0
5-06	(Thermal time constant)	30 to 600s	1	s	60
5-07	Alarm history (Latest)	0:No alarm records	-	-	0
5-08	(1 st last)	1:OC (Over current)	-	-	0
5-09	(2 nd last)	2:OV (Over voltage)	-	-	0
5-10	(3 rd last)	3:OH (Over heating of heat sink)	-	-	0
5-11	(4 th last)	4:OL (Overload of inverter "overheating of IGBT")	-	-	0
5-12	(5 th last)	5:OL1 (Motor overload) (Overload of motor 1) 6:EF (External fault) 16:CF2 (Read error of internal storage IC data) 17:External alarm signal input 18:OL2 (Overload of motor 2) 22:CF3.1 (Internal temperature is over high or circuit fault at power-on test) 23:CF3.2 (Over voltage of internal DC voltage side at power-on test) 24:CF3.3 (Under voltage of internal DC voltage side at power-on test) 29:HPF.1 (Over voltage protection circuit fault) 31:HPF.3 (Over current protection circuit fault) 37:Errb (Wobble frequency setting error)	-	-	0

Motor Parameters

Code	Name	Data Setting range	Increment	Unit	Default setting
7-00	Motor (Rated current)	30 to 120%	1	%	85
7-01	(No load current)	0 to 90%	1	%	30
7-03	Auto slip compensation setting	0.0 to 10.0	0.1	-	0.0
7-11	Motor (Rated speed)	500 to 3000min ⁻¹	1	min ⁻¹	1450
7-12	(Pole number)	0 to 30pole	2	Poles	4
7-13	(Rated frequency)	5.0 to 400Hz	0.1	Hz	50.0

High Function Parameters

Code	Name	Data Setting range	Increment	Unit	Default setting
8-00	DC braking (Braking level)	0.0 to 100%	0.1	%	0.0
8-01	(Braking time at starting)	0.0 to 60.0s	0.1	s	0.0
8-02	(Braking time at stopping)	0.0 to 60.0s	0.1	s	0.0
8-03	(Braking starting frequency)	0.1 to 60.0Hz	0.1	Hz	1.0
8-04	Restart after momentary power failure (Mode selection)	0:Inactive (Trip immediately) 1:Active (Restart at the frequency at which the power failure occurred, for general loads) 2:Active (Restart at the starting frequency, for light inertia loads)	-	-	0
8-05	(Max allowable time for power failure)	0.3 to 5.0s	0.1	s	2.0
8-06	(Restart time)	0.3 to 5.0s	0.1	s	0.5
8-07	(Max current setting for speed tracking)	30 to 200%	1	%	150
8-08	Jump frequency 1 (Upper)	0.0 to 400Hz	0.1	Hz	0.0
8-09	(Lower)	0.0 to 400Hz	0.1	Hz	0.0
8-10	Jump frequency 2 (Upper)	0.0 to 400Hz	0.1	Hz	0.0
8-11	(Lower)	0.0 to 400Hz	0.1	Hz	0.0
8-12	Jump frequency 3 (Upper)	0.0 to 400Hz	0.1	Hz	0.0
8-13	(Lower)	0.0 to 400Hz	0.1	Hz	0.0
8-14	Auto-reset (Times)	0 to 10	1	-	0
8-15	AVR function selection	0:AVR function available 1:AVR function unavailable 2:AVR function cancelled during deceleration	-	-	1
8-20	Auto-reset (Counter clear time)	1 to 100 min	1	min	10
8-22	Auto-reset (Reset interval)	0.1 to 20.0s	0.1	s	2.0

Communication Parameters

Code	Name	Data Setting range	Increment	Unit	Default setting
9-00	RS-485 Communications (Station address)	1 to 247	1	-	1
9-01	(Baud rate)	0:Baud rate 4800 bps 1:Baud rate 9600 2:Baud rate 14400 3:Baud rate 19200 4:Baud rate 38400	-	-	1
9-02	(Communications error processing)	0:Warning and running continuously 1:Warning and deceleration to stop 2:Warning and coasting to a stop 3:No warning and running continuously	-	-	0
9-03	(No-response error detection time)	0:Not detected 1 to 20s	1	s	0
9-04	(Communications format) <Data length, Parity, STOP bit>	0:ASCII mode <8, N,1> 1:ASCII mode <8, N,2> 2:ASCII mode <8, E,1> 3:ASCII mode <8, E,2> 4:ASCII mode <8, O,1> 5:ASCII mode <8, O,2> 6:RTU mode <8, N,2> 7:RTU mode <8, E,1> 8:RTU mode <8, O,1>	-	-	0
9-07	(Response interval)	0 to 200 (one unit=2ms)	1	-	1

Wobble Frequency Function Parameters

Code	Name	Data Setting range	Increment	Unit	Default setting
R-00	Wobble frequency selection	0:Not applying 1:Applying	-	-	0
R-01	Wobble frequency input mode	0:Set according to wobble frequency action delay 1:Controlled by external terminals.	-	-	0
R-02	Pre-set frequency of wobble Frequency	0.0 to 400Hz	0.1	Hz	0.0
R-03	Action delay setting of preset wobble frequency	0.0 to 600s	0.1	s	0.0
R-04	Central frequency of wobble frequency	0:According to operation frequency source 1:According to fixed frequency setting (A-05)	-	-	0
R-05	Fixed central frequency setting of wobble frequency (Max frequency base)	0.01 to 100%	0.1	%	20.0
R-06	Reference source setting for wobble aptitude	0:Centering frequency base 1:Max frequency (1-00) base	-	-	0
R-07	Wobble aptitude width setting	0.0 to 50.0%	0.1	%	0.0
R-08	Wobble frequency hopping (Relative aptitude)	0.0 to 50.0%	0.1	%	0.0
R-09	Wobble frequency cycle	0.1 to 655s	0.1	s	10.0
R-10	Triangle wave rising time (Relative cycle)	0.1 to 99.9%	0.1	%	50.0
R-11	Wobble frequency machine stop starting mode	0:Starting in memorizing state before stop 1:Restarting	-	-	0
R-12	Wobble state power loss memory	0:Memorizing 1:Non-memorizing	-	-	0

<Changing, validating and saving data during operation>

□: Not possible □:After changing with the ◀▶ keys, validate or save the data with "ENTER" key.

Precautions for use

When running general-purpose motors	Driving a 400V general-purpose motor	When driving a 400V general-purpose motor with an inverter, damage to the insulation of the motor may occur. Use an output circuit filter (OFL) if necessary after checking with the motor manufacturer. Fuji motors do not require the use of output circuit filters because of superior insulation.
	Torque characteristics and temperature rise	When the inverter is used to run a general-purpose motor, the temperature of the motor becomes higher than when it is operated using a commercial power supply. In the low-speed range, cooling effect will be weakened, so decrease the output torque of the motor. If constant torque is required in the low-speed range, use a Fuji inverter motor or a motor equipped with an externally powered ventilating fan.
	Vibration	When an inverter-driven motor is mounted to a machine, resonance may be caused by the natural frequencies of the machine system. Note that operation of a 2-pole motor at 60Hz or higher may cause abnormal vibration. * The use of a rubber coupling or vibration dampening rubber is recommended. * Use the inverter's "jump frequency control" feature to skip the resonance frequency zone(s).
	Noise	When an inverter is used with a general-purpose motor, the motor noise level is higher than that with a commercial power supply. To reduce noise, raise the carrier frequency of the inverter. Operation at 60Hz or higher can also result in higher noise level.
When running special motors	High-speed motors	If the reference frequency is set to 120Hz or more to drive a high speed motor, test-run the combination of the inverter and motor beforehand to check for safe operation.
	Explosion-proof motors	When driving an explosion-proof motor with an inverter, use a combination of a motor and an inverter that has been approved in advance.
	Submersible motors and pumps	These motors have a larger rated current than general-purpose motors. Select an inverter whose rated output current is greater than that of the motor. These motors differ from general-purpose motors in thermal characteristics. Set a low value in the "thermal time constant" of the motor when setting the electronic thermal function.
	Brake motors	For motors equipped with parallel-connected brakes, their braking power must be connected and supplied from the inverter's input (primary) circuit. If the brake power is connected to the inverter's output (secondary) circuit by mistake, the brake will not work. Do not use inverters for driving motors equipped with series-connected brakes.
	Geared motors	If the power transmission mechanism uses an oil-lubricated gearbox or speed changer/reducer, then continuous motor operation at low speed may cause poor lubrication. Avoid such operation.
	Synchronous motors	It is necessary to take special measures suitable for this motor type. Contact your Fuji Electric representative for details.
	Single-phase motors	Single-phase motors are not suitable for inverter-driven variable speed operation. Even if a single-phase power supply is available, use a three-phase motor as the inverter provides three-phase output.
Environmental conditions	Installation location	Use the inverter within the ambient temperature range from -10 to +50°C. The heat sink and braking resistor of the inverter may become hot under certain operating conditions, so install the inverter on nonflammable material such as metal. Ensure that the installation location meets the environmental conditions specified in section "Operating Environment."
Combination with peripheral devices	Installing a molded case circuit breaker (MCCB)	Install a recommended molded case circuit breaker (MCCB) or earth leakage circuit breaker (ELCB) (with overcurrent protection) in the input (primary) circuit of the inverter to protect the wiring. Ensure that the circuit breaker capacity is equivalent to or lower than the recommended capacity.
	Installing a magnetic contactor (MC) in the output (secondary) circuit	If a magnetic contactor (MC) is mounted in the inverter's secondary circuit for switching the motor to commercial power, ensure that both the inverter and the motor are completely stopped before you turn the MC on or off. Do not connect a magnet contactor with an integrated surge killer to the inverter's secondary circuit.
	Installing a magnetic contactor (MC) in the input (primary) circuit	Do not turn the magnetic contactor (MC) in the input (primary) circuit on or off more than once an hour as an inverter failure may result. If frequent starts or stops are required during motor operation, use FWD/REV signals on the control circuit terminal.
	Protecting the motor	The electronic thermal function of the inverter can protect the motor. The operation level and the motor type (general-purpose motor, inverter motor) should be set. For high speed motors or water-cooled motors, setting a small value for the thermal time constant combined with a separate "cooling system fault" detection function protect the motor. If you connect the motor thermal relay to the motor with a long wire, a high-frequency current may flow into the wiring stray capacitance. This may cause the relay to trip at a current lower than the set value for the thermal relay. If this happens, lower the carrier frequency or use the output circuit filter (OFL).
	Discontinuance of power-factor correcting capacitor	Do not mount power-factor correcting capacitors in the inverter's primary circuit because it has no effect. Use the AC reactor to improve the inverter power factor. Do not use power-factor correcting capacitors in the inverter output circuit (secondary). An overcurrent trip will occur, disabling motor operation.
	Discontinuance of surge killer	Do not connect a surge killer to the inverter's secondary circuit.
	Reducing noise	Use of a filter and shielded wires is typically recommended to satisfy EMC directives.
	Measures against surge currents	If an overvoltage trip occurs while the inverter is stopped or operated under a light load, it is assumed that the surge current is generated by open/close of the phase-advancing capacitor in the power system. Connect an AC reactor to the inverter as a measure on the inverter side.
Wiring	Control circuit wiring length	When using remote control, limit the wiring length between the inverter and operator box to 20m or less and use twisted pair or shielded cable.
	Wiring length between inverter and motor	If long wiring is used between the inverter and the motor, the inverter will overheat or trip as a result of overcurrent (high-frequency current flowing into the stray capacitance) in the wires connected to the phases. Ensure that the wiring is shorter than 50m. If this length must be exceeded, lower the carrier frequency or mount an output circuit filter (OFL).
	Wiring size	Select wires with a sufficient capacity by referring to the current value or recommended wire size.
	Wiring type	Do not use a single multicore cable in order to connect several inverters with motors.
	Grounding	Securely ground the inverter using the grounding terminal.
Selecting inverter capacity	Driving general-purpose motor	Select an inverter according to the nominal applied motor listed in the standard specifications table for the inverter. When high starting torque is required or quick acceleration or deceleration is required, select an inverter with a capacity one size greater than the standard.
	Driving special motors	Select an inverter that meets the following condition: Inverter rated current > Motor rated current
Transporting and storage		For transporting and storing inverters, select a method and location that meets the inverter's specifications for environmental conditions.

MEMO